

VN-Ring



Axiaal ringventilator met norm motor.

De informatie betreft de standaard range. De mogelijkheden zijn zeer uitgebreid en naast de diameter en het toerental wordt de ventilator geconfigureerd door middel van het type waaier, de schoephoek van de waaier en het motorvermogen.

Zoekt u een ventilator voor een specifiek werkpunt, neem dan gerust contact met ons op via 0416 391999 of info@ventinet.nl en we zullen een passende uitvoering voor u selecteren.

Afmetingen	310 t/m 1.250 mm
Motor (standaard)	Norm motor IP55, 230/1/50 of 400/3/50
Capaciteit	t/m 80.000 m ³ /h
Druk	t/m 750 Pa
Regeling	Frequentie regeling
Behuizing	Staal / Aluminium / RVS
Waaier	Kunststof / Aluminium
Luchtstroom	Motor → Waaier / Waaier → Motor
Extra	Motoren voor alle spanningen, frequenties en met certificaten mogelijk
Atex	 Gas : zone 1 II2G en 2 II3G Stof op aanvraag : zone 21 II2D en 22 II3D
Accessoires	Roosters / Dempers / Kleppen / Werkschakelaars / Aansluitdoos / Frequentie regelaars

2 polig (3.000 opm.) – 230/1/50

Model	Capaciteit max. (m ³ /h)	50 Pa m ³ /h	150 Pa m ³ /h	300 Pa m ³ /h	Druk max. (Pa stat.)	Motor (kW)	In max. (A)
312 M	3.500	3.200	2.350	-	240	0,25	1,70
352 M	5.250	5.000	4.400	3.150	450	0,55	4,00
402 M	8.200	8.200	7.500	6.200	450	1,10	8,00

2 polig (3.000 opm.) – 400/3/50

Model	Capaciteit max. (m ³ /h)	50 Pa m ³ /h	150 Pa m ³ /h	300 Pa m ³ /h	Druk max. (Pa stat.)	Motor (kW)	In max. (A)
312 T	3.500	3.200	2.350	-	240	0,25	0,70
352 T	5.250	5.000	4.400	3.150	450	0,55	1,60
402 T	8.200	8.200	7.500	6.200	450	1,10	2,60

4 polig (1.500 opm.) – 230/1/50

Model	Capaciteit max. (m ³ /h)	50 Pa m ³ /h	75 Pa m ³ /h	100 Pa m ³ /h	Druk max. (Pa stat.)	Motor (kW)	In max. (A)
314 M	2.300	1.700	-	-	65	0,09	1,00
354 M	3.200	2.800	2.400	1.250	130	0,09	1,00
404/A M	4.000	3.100	2.250	1.600	110	0,12	1,10
404/B M	5.200	4.700	4.000	2.000	120	0,18	1,40
454/A M	6.500	5.750	5.000	3.900	140	0,25	1,80
454/B M	7.600	6.800	6.100	5.000	120	0,37	3,30

4 polig (1.500 opm.) – 400/3/50

Model	Capaciteit max. (m ³ /h)	50 Pa m ³ /h	150 Pa m ³ /h	300 Pa m ³ /h	Druk max. (Pa stat.)	Motor (kW)	In max. (A)
314 T	2.300	1.700	-	-	65	0,09	0,40
354 T	3.200	2.800	-	-	130	0,09	0,40
404/A T	4.000	3.100	-	-	110	0,12	0,50
404/B T	5.200	4.700	-	-	120	0,18	0,60
454/A T	6.500	5.750	-	-	140	0,25	0,80
454/B T	7.600	6.800	-	-	120	0,37	1,20
504/A T	8.000	7.200	2.750	-	160	0,37	1,20
504/B T	9.000	8.250	3.000	-	180	0,55	1,60
564/A T	10.000	9.100	5.500	-	190	0,55	1,60
564/B T	12.500	11.600	7.400	-	195	0,75	2,00
634/A T	13.000	12.100	8.500	-	210	0,75	2,00
634/B T	16.000	15.100	12.300	-	220	1,1	2,80
634/C T	17.000	16.350	14.900	10.800	300	2,2	5,00
714/A T	17.000	15.800	12.400	-	240	1,5	3,50
714/B T	20.500	19.300	15.500	-	240	2,2	5,00
714/C T	18.500	18.500	16.800	-	280	2,2	5,00
714/D T	23.500	22.400	20.900	15.700	300	3	6,50
804/A T	24.000	23.000	21.000	17.000	530	3	6,50
804/B T	29.000	28.000	26.000	22.000	550	4	8,20
804/C T	35.000	34.000	32.000	28.000	570	5,5	11,0
804/D T	40.000	39.000	38.000	35.500	450	7,5	15,0
904/A T	38.000	37.000	34.500	30.000	600	5,5	11,0
904/B T	43.000	42.000	38.000	33.000	620	7,5	15,0
904/C T	47.000	46.000	42.500	37.500	470	7,5	15,0

904/D T	52.500	51.500	48.000	42.500	450	9,2	18,0
1004/A T	41.000	40.000	37.000	32.000	610	5,5	11,0
1004/B T	50.000	49.000	46.000	40.500	680	7,5	15,0
1004/C T	59.000	58.000	55.000	50.000	620	11	21,0

6 polig (1.000 opm.) – 400/3/50

Model	Capaciteit max. (m ³ /h)	50 Pa m ³ /h	150 Pa m ³ /h	250 Pa m ³ /h	Druk max. (Pa stat.)	Motor (kW)	In max. (A)
506 T	6.000	4.100	-	-	80	0,18	0,70
566 T	8.500	7.100	-	-	80	0,25	1,00
636/A T	12.000	9.500	-	-	100	0,37	1,30
636/B T	14.000	13.200	-	-	140	0,75	2,20
716/A T	16.000	14.000	-	-	110	0,75	2,20
716/B T	17.000	15.300	11.000	-	180	1,10	3,00
806/A T	16.000	14.000	8.000	-	210	0,75	2,20
806/B T	19.000	18.000	12.500	5.500	260	1,1	3,00
806/C T	22.500	21.500	17.000	7.000	275	1,5	4,00
906/A T	25.000	23.000	18.500	8.800	280	1,5	4,00
906/B T	29.000	27.000	22.500	11.200	285	2,2	5,00
906/C T	32.000	30.000	24.000	13.000	290	2,2	5,00
1006/A T	27.000	24.500	18.000	10.000	250	1,5	4,00
1006/B T	33.000	30.000	23.300	13.000	280	2,2	5,00
1006/C T	41.000	38.000	30.000	16.500	300	3	7,00
1126/B T	45.000	43.000	37.000	26.500	280	4	9,00
1126/C T	54.000	52.000	47.000	36.500	350	5,5	12,0
1256/B T	55.000	53.000	49.500	42.500	380	7,5	15,0
1256/C T	70.000	68.000	63.000	56.000	440	11	22,0

8 polig (750 opm.) – 400/3/50

Model	Capaciteit max. (m ³ /h)	50 Pa m ³ /h	100 Pa m ³ /h	200 Pa m ³ /h	Druk max. (Pa stat.)	Motor (kW)	In max. (A)
568 T	6.000	-	-	-	45	0,12	0,70
638 T	8.000	3.800	-	-	60	0,18	0,80
718 T	11.000	6.600	-	-	61	0,37	1,50
808/A T	10.000	8.800	6.100	-	100	0,37	1,50
808/B T	13.000	11.200	7.000	-	125	0,37	1,50
908/A T	17.000	14.500	9.000	-	170	0,75	2,30
908/B	20.500	17.300	12.500	-	175	0,75	2,30
1008/A T	20.500	17.500	12.000	-	150	0,75	2,30
1008/B T	25.000	22.400	15.300	-	150	1,1	3,40
1128 /C T	40.500	38.000	33.000	15.400	200	2,2	5,50
1258/A T	34.500	32.500	27.000	14.000	225	2,2	5,50
1258/B T	43.000	41.200	35.500	17.000	225	3	7,30
1258/C T	52.000	49.500	45.200	20.200	225	4	9,30

[Typefouten en wijzigingen voorbehouden]

Maatindicatie VN-Ring

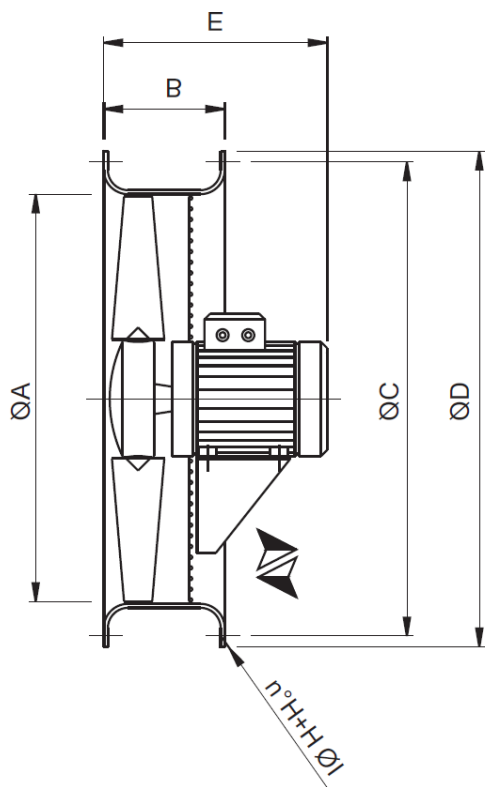

Model	Ø A	B	Ø C	Ø D	E*	Ø F	Ø G	n°H	Ø I	n°L	Ø M
31	310	150	365	390	330	-	-	4	8	-	-
35	360	150	430	455	350	-	-	4	8	-	-
40	410	150	480	510	370	450	480	4	10	8	12
45	460	150	535	560	370	500	530	4	10	8	12
50	510	150	590	620	370	560	595	8	10	12	12
56	570	180	645	680	400	620	655	8	10	12	12
63	640	180	720	750	440	690	725	8	10	12	12
71	710	180	780	816	480	770	805	8	12	16	12
80	810	200	880	915	610	860	900	8	12	16	12
90	910	250	980	1015	660	970	1010	16	12	16	16
100	1010	250	1080	1115	790	1070	1110	16	12	16	16
112	1130	250	1226	1250	720	1190	1230	16	12	16	16
125	1260	250	1350	1380	790	1320	1360	16	12	16	16

*E → Afhankelijk van type motor